











ZW-33Z

Cross-beam LED Digital Control Box



 SENSITIVITY ADJUSTABLE	 LED DISPLAY	 HIGH PRECISION	 VOLUME ADJUSTABLE	 LED LIGHT INDICATOR	
 PASSWORD PROTECTION	 MODULAR DESIGN	 WIDTH CUSTOMIZABLE	 ACCESS CONTROL CONNECTING	 PC NETWORKING	 UPS BATTERY

- Medium-sized sleek design dark grey premium finish;
- High sensitivity 33 zones (11vertical 3 lateral);
- Detect ferrous & non-ferrous metal objects;
- Pre-set 72 scene for easy operation;
- Comply with EMC electromagnetic radiation standards and adopt weak magnetic field technology, harmless to pacemaker wearers, pregnant women, floppy disks, film and video tapes

Conform to Electricity EN60950 Safety Standard

Conform to Radiation EN50081-1 Standard

Conform to Anti-interference EN50082-1 Standard



ZW-33Z

Product Specification

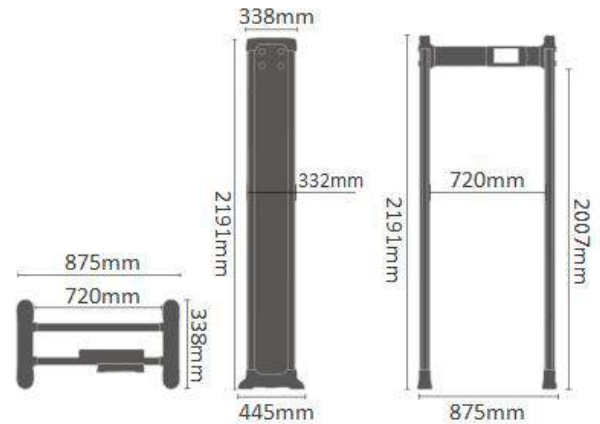

Overall Exterior Size	2191*875*445mm
Passageway Interior Size	2007*720*445mm
Operating Voltage	AC100V ~ 240V 50 / 60Hz
Power	12W
Operating Temperatures	-20°C ~ 65°C
Installation Environment	Width 100cm* Length 200cm (minimum range without metal)



Function Configuration

Detection Zones	11-22-33 Zones
Pass Count	0-99999
Alarm Count	0-99999
Metal Detection Accuracy Range	One-dollar coin
User Interface	Dual sets of bright red and green digital tube display + integrated four-button panel operation mode
Password Protection Function	5-digit password protection
Metal Position Indicator	Intelligent zoning indication
Operating Frequency	0-99
Security Level	0-99
Sensitivity Level	0-400
Alarm Volume	0-99
Alarm Tone	0-99
Alarm Time	0-99
Scene Setting	72 preset scenes
Infrared Setting	0-Both groups OFF 1-Front group ON 2-Rear group ON 3-Both groups ON
Left and right LED Bars	Interchangeable
LED Alarm Bars	Front 2 groups
Simultaneous detection and alarm in multiple zones	2 Detection zones simultaneously alarm

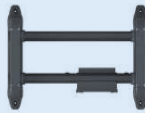
ZW-33Z

Optional Functions: The above zones can be equipped with the following functions		
<input type="checkbox"/> Turnstile Connection	 <p>With optional functions</p>	 <p>No optional functions</p>
<input type="checkbox"/> Networking Interfaces for Multiple Units		
<input type="checkbox"/> Back up Battery : 4/8/16 Hours		
<input type="checkbox"/> Front and Rear Panel Alarm LED Lights		
<input type="checkbox"/> Secondary Development Port/Upgrade Port		

Interface Display

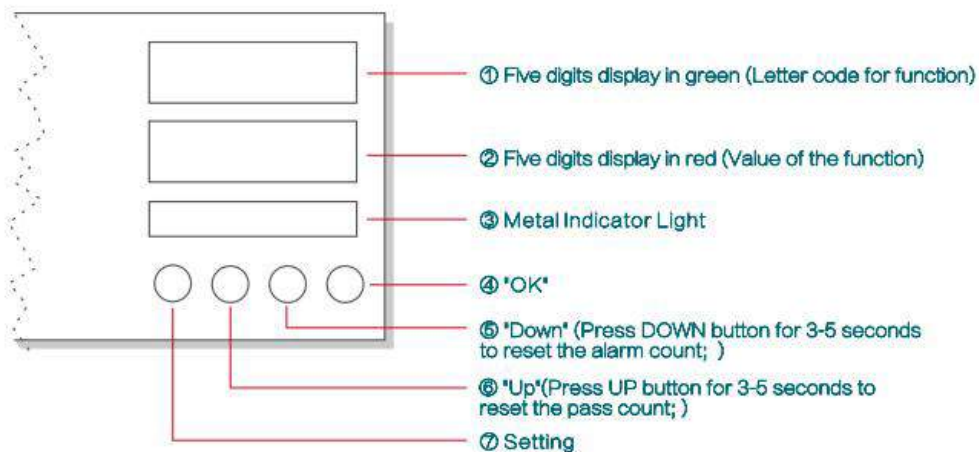

Anti-interference Reference Standard



Note: The above distances are for reference only, and the actual distances shall be subject to the performance accuracy of on-site debugging; the higher the sensitivity, the greater the distance interval, and the lower the sensitivity, the smaller the distance interval.

ZW-33Z

Test kits

The diagram shows a person in a suit walking through a metal detector. A callout box lists the following test kit items:

- A dime
- Fifty cent coin
- One-dollar coin
- Paper clip
- Pin
- B1: Small iron piece VS utility knife blade (Magnetic/Non-Magnetic)
- B2: Big iron VS saber
- Q4: Cylindrical VS Pistol Magazine
- DJ: Red L-shaped cylinder VS grenade
- Q1: Yellow L-shaped cylinder VS small pistol
- Q2: Green L-shaped cylinder VS revolver
- Q3: Blue L-shaped cylinder VS big pistol

Detection Zone

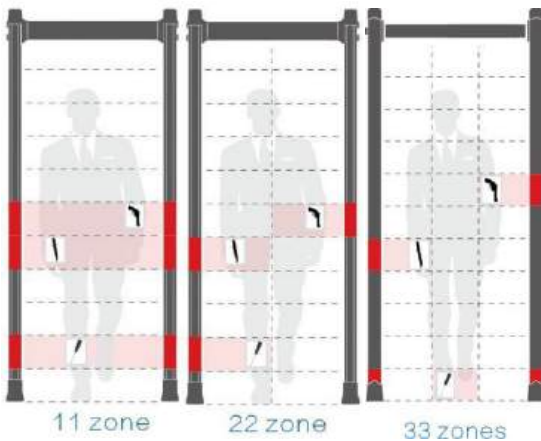

Package

Packaging:	Carton box
Package Size:	L2285xW665xH215mm
Volume:	0.33m ³
Net weight:	35kgs
Gross weight:	42kgs

